

Lubrication Unit NSK K1™

Used on NSK Linear Guides™, Ball Screws and Monocarriers™



NSK Patent

Fifteen years of proven efficiency in providing lubrication



Lubrication unit NSK K1™ for food processing and medical equipment is also available.

Lubrication Unit NSK K1™

- NSK K1 lubrication unit equipped with an NSK linear guide, ball screw and Monocarrier is an outstanding new lubrication material.
- A Newly developed porous synthetic resin contains large volume of lubricant oil that seeps out and enhances lubricating function.

NSK K1 lowers machine operation cost, and reduces impact on the environment. NSK K1 is a lubrication device which combines oil and resin in a single unit. The porous resin contains a large amount of lubrication oil. Touching its surface to the raceway of a rail close to the ball contact point NSK K1 constantly supplies fresh oil which seeps from the resin.

You can achieve the following:

- Long-term maintenance-free (cost reduction)
 - Long life under severe environments
 - Environmentally sound clean lubrication system
- Lubricant oil and polyolefin combined and molded into one unit**
- Containing 70% of lubrication oil
 - Supplies lubricant oil for long periods of time (Service life: in excess of 100 000 hours)

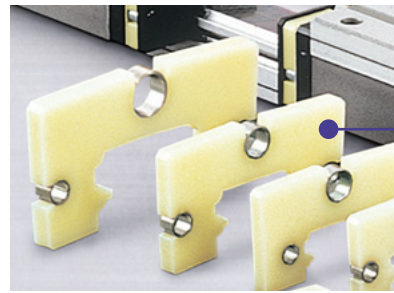

Magnification of NSK K1

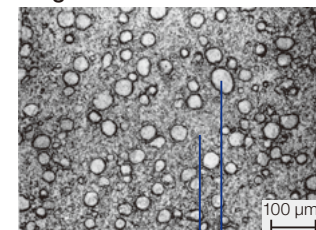

Portion containing high proportion of lubricating oil
Portion containing high proportion of polyolefin

NSK Linear Guides equipped with NSK K1

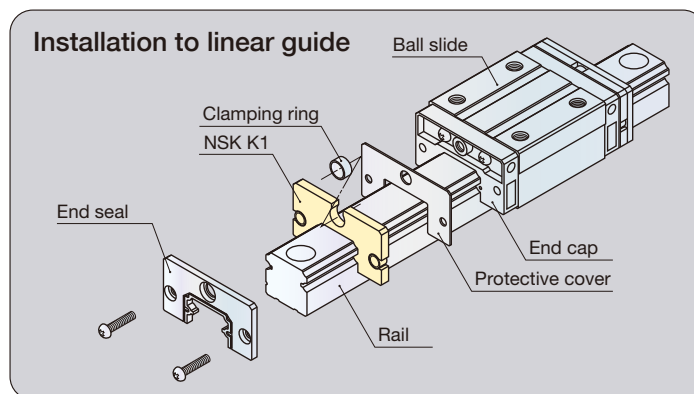
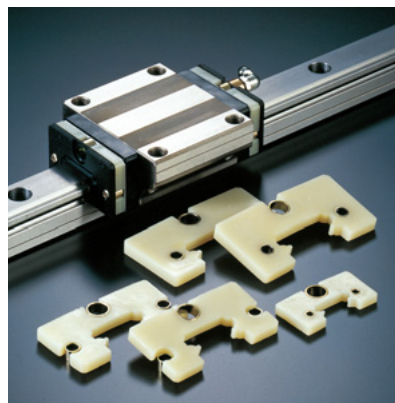

Features of NSK Linear Guides equipped with NSK K1

With the NSK K1 lubrication unit, maintenance is unnecessary for more than five years or 10 000 km. Simply attach the unit inside the standard end seal. The NSK K1 lubrication unit is also available for use with food machinery, medical equipment and peripherals in environments with strict hygienic or sanitation restrictions. See page 5 for details.

Ball Screws equipped with NSK K1

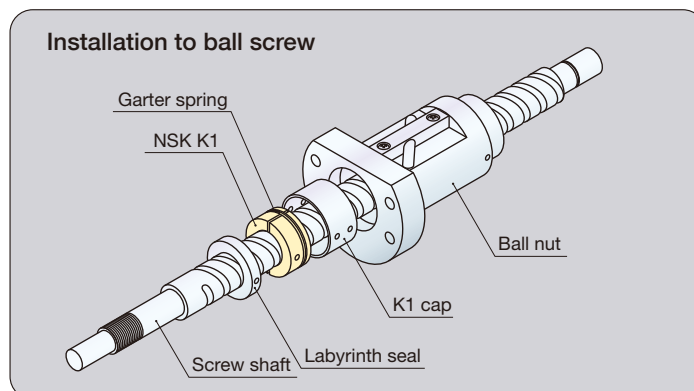
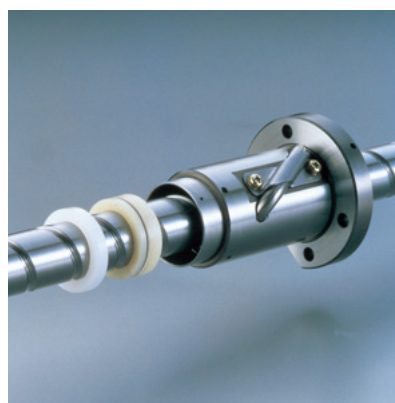

What this unit can achieve:

1 Long-Term Maintenance Free → Cost Down

We want to reduce the workload and cost of replenishing oil and grease...
We want to eliminate piping for oil supply...
We cannot suspend our production line for replenishing oil...

A lubrication system equipped with the NSK K1 lubrication unit is maintenance free for more than five years or 10 000 kilometers.

Conventional system

Supplying oil using a lubrication unit and centralized piping

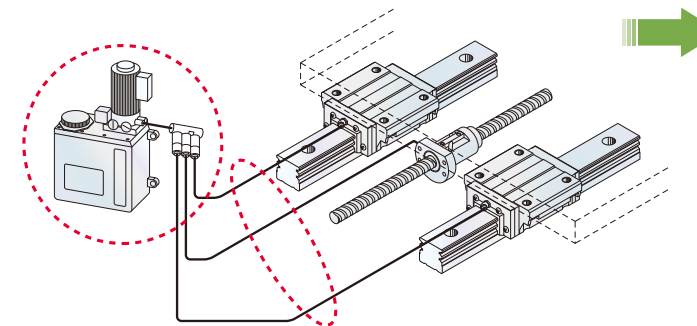

New lubrication system

Using the NSK K1 lubrication unit

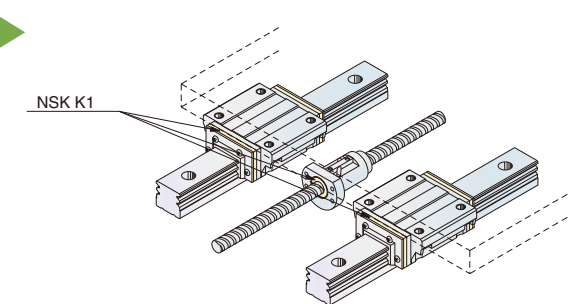

Advantages:

- A reduction in expenditure on oil or grease cost by making it unnecessary to replenish lubricants for an extended period
- A reduction in personnel costs for regular maintenance
- A reduction in the cost of designing and replenishing piping or equipment, parts expenditures, and lead time for assembly
- A reduction in the cost for coolants and in processing oil waste (No lubricant contamination → Prolonged life of coolants)

Comparison test between NSK K1 and standard seal

(1) Linear guide

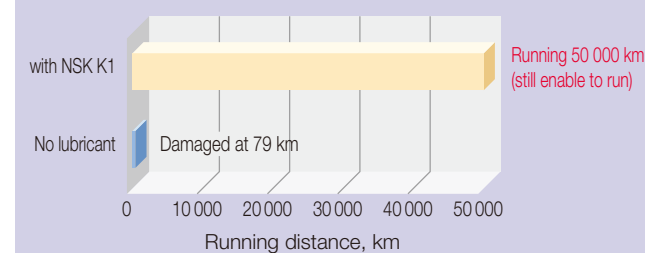

Sample: LH30 (slight preload)
Lubrication: 1) Only NSK K1
2) No lubricant
Load: None
Speed: 60 m/min
Stroke: 750 mm

(2) Ball screw

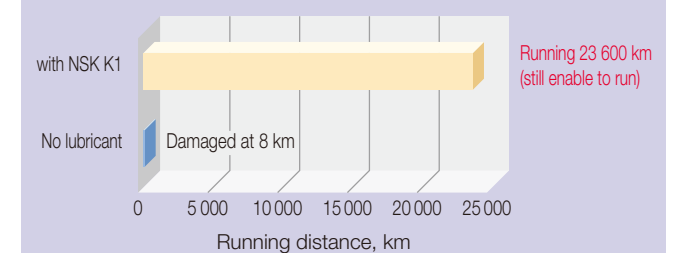

Sample: Shaft dia. 20 mm, lead 20 mm
Lubrication: 1) Only NSK K1
2) No lubricant
Load: None
Speed: 4 000 min⁻¹
Stroke: 450 mm

What this unit can achieve:

2 Long Life even in Severe Environments

- Shortened service life because of
- Contaminated environments
 - Quick deterioration of lubricants absorbed by dust
 - Lubricant deteriorates or is washed away by water seepage

Use of the NSK K1 lubrication unit significantly prolongs the life of your machinery, even in severe contaminated environments or undesirable environments for lubrication

Advantages:

- A reduction in maintenance cost, including repair parts and personnel
- Longer time between repairs → shortened down-time on the production line → Improved productivity

● Example of severe environments

- Contaminated environments; Machine tools, welding machines, etc.
- Environments where oil- and grease absorbing dust is produced; Woodworking machines, textile machines, papermaking machines, printing machines, etc.
- Environments where lubricant is washed away; Machines that are washed away entirely by water, machines that are exposed to rain or water.

Note: Rust preventive treatment is required for corrosive environments.

● Test result of ball screws in contaminated environments

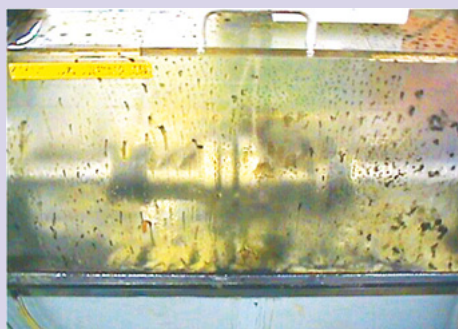

Sample: Screw shaft dia. 40 mm, lead 10 mm
 Circuit: 2.5 × 1
 Lubrication: 1) AS2 Grease (packed before operation only)
 2) AS2 Grease (packed before operation only) + NSK K1
 Load: 3.9 kN
 Speed: 2 000 min⁻¹ (20 m/min)
 Stroke: 340 mm
 Contamination: Dropped contaminants onto screw shaft periodically.
 FCD45 particle 115 MESH added at coolant
 (Coolant dilution 30:1)
 Volume of contaminant: Coolant 3 600 cm³ + casting particles 1.8 g/day

Test result: abrasion on nut grooves of a ball screw (perpendicular surface) (Running distance: 1 864 km)

(1) Without NSK K1

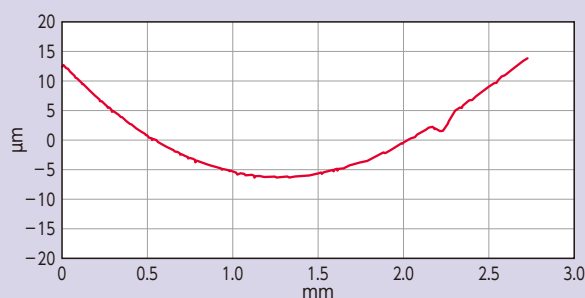

Abrasion higher than 20 µm (when abrasion is spread all over the grooves)

(2) With NSK K1

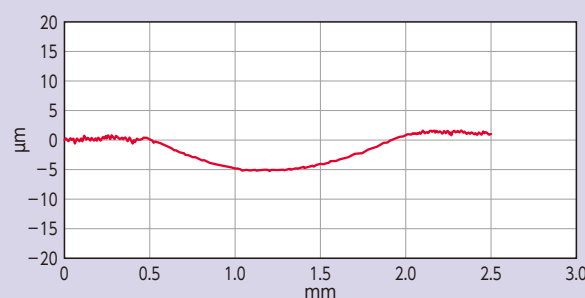

Abrasion around 5 to 6 µm (normal abrasion conditions)

Use of the NSK K1 lubrication unit has reduced abrasion of ball screws by **75%**.

What this unit can achieve:

3 A Clean Lubrication System That is Environmentally Friendly

We want to avoid contamination by oil dispersion... We don't like coolant decomposition and odor caused by lubricant oil falling into coolants.

By using the NSK K1 lubrication unit, you can solve these problems and achieve a clean and environmentally sound machinery/equipment system.

Merit

- Suitable for machinery or equipment used where exposed lubricants should be avoided, such as food processing machinery, medical equipment, or engineering and textile machinery.
- Suitable for machinery or equipment that requires extremely high levels of cleanliness, such as semiconductor and LCD fabrication-related equipment.
- Improvement of work environment

● Adjacent areas for NSK K1 installed linear guide

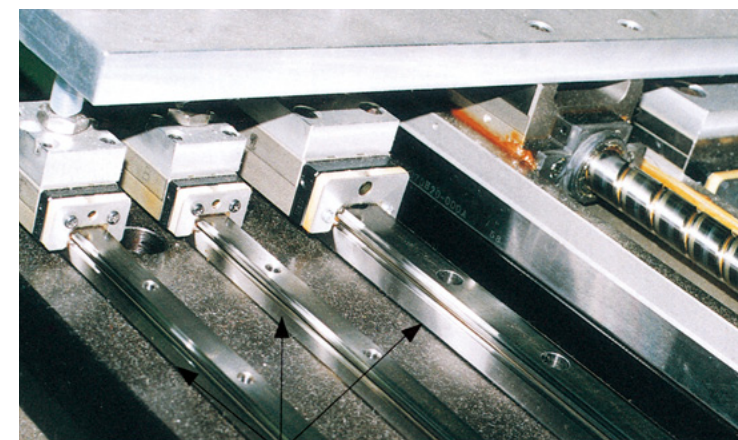

NSK K1 installed linear guide

Replenishing grease is not required, so machines are kept clean.

Precautions for handling

To maintain high functionality of the NSK K1, observe the following precautions.

1. Temperature range for use: Maximum temperature in use: 50°C
Momentary maximum temperature in use: 80°C
2. Chemicals that should not come into contact with NSK K1:
Do not leave the NSK K1 in an organic solvent, such as hexane and thinner that remove oil, or rust preventive oil that contains white kerosene.

Note: Water-type cutting oil, oil-type cutting oil, mineral-oil type grease and ester-type grease do not damage NSK K1.

NSK Linear Guides for Food Processing and Medical Equipment in Sanitary Environments

The NSK K1 lubrication unit for food processing and medical equipment is safe and secure. NSK K1 FDA-compliant material is used for the lubrication unit, so it is used without anxiety for food processing and medical equipment.

- The NSK K1 lubrication unit for food processing and medical equipment is a phenomenal new material seal that is safe and secure.
- The newly developed porous synthetic resin contains abundant lubricant.
- With the basic functions of highly praised NSK K1 for general industry, more sophisticated materials make it applicable in food and medical equipment.
- It also offers easy installation, mounted inside the standard end seal (rubber).



Features of NSK K1 Lubrication Unit for Food and Medical Equipment

- **Very safe to handle**
Uses highly safe materials that are compliant with the US Food and Drug Administration's (FDA) hygiene standards for food additives.
- **Environmentally sound**
The newly developed porous synthetic resin provides a controlled supply of lubricant, preventing the dispersion of oil in sanitary environments.
- **Resistant to harsh environments**
It is durable not only under normal environments, but also under harsh environments, such as machinery submerged in water.

Features of NSK Linear Guides for Sanitary Environments

- **The highest grade of category H1 grease of USDA standard is used for NSK K1 lubrication unit.**
*category H1: Lubricants permitted for use where there is possibility of incidental food contact
*USDA: USDA (The United States Department of Agriculture)
<Features of grease for food processing machines>
 - This grease is approved by USDA H1. (National Science Foundation [NSF] carries out certification for USDA.)
 - Superb water resistance and antirust capability
 - Superb wear resistance
 - Applicable for a centralized oiling system
- **Appropriate volume of grease**
A supply of appropriate volume of grease reduces grease draining and scattering, and maintains a clean environment.

The table below shows available models.

LH Series	LH12, LH15, LH20, LH25, LH30, LH35
LS Series	LS15, LS20, LS25, LS30, LS35
LW Series	LW17, LW21, LW27, LW35
PU Series	PU09, PU12, PU15
LU Series	LU09, LU12, LU15
PE Series	PE09, PE12, PE15
LE Series	LE09, LE12, LE15

Introduction of Performance by Use

1 Automotive Manufacturing Equipment

Maintenance Free, Long Life even in Severe Environments

Actual results from welding machines, the most severe environment in automotive plants

Operating conditions

Sample: LH300200ELC1-PCZ
 No.1: Double seal + Protector (no NSK K1)
 No.2: NSK K1 attached + Single seal + Protector
 Tested on the same welding machine at the same place in automotive production line
 Sample No.1: 10.5-month operation
 Sample No.2: 13-month operation



Comparison after running

Sample No.1 (without NSK K1)
 : Rail and ball slide raceways and balls showed rust and extensive deterioration
 Sample No.2 (with NSK K1)
 : Rail and ball slide raceways and balls had no rust and only slight deterioration

Ball deterioration

Sample No.1
(without NSK K1)



Sample No.2
(with NSK K1)



Rail raceway deterioration

Sample No.1
(without NSK K1)

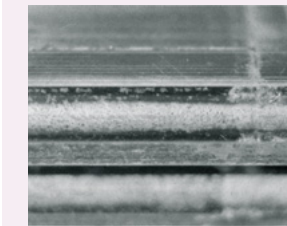

Sample No.2
(with NSK K1)

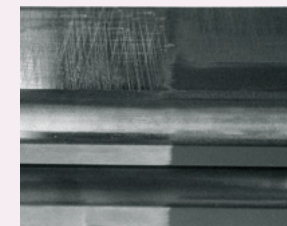

Merit

- Reduced expense for lubricants (see graph in the right)
- No oil or grease supply systems required
→ **Reduced equipment cost**
- Improved machine design time and efficiency
→ **No piping design required**
- Long-term maintenance free
→ **Reduced maintenance cost**
- Better for the environment
→ **NSK K1 reduces lubricant consumption, minimizes waste oil**

Comparison of lubricant consumption

Estimated oil consumption in the test equivalent to 5 years running (for 4 LH45 slides)

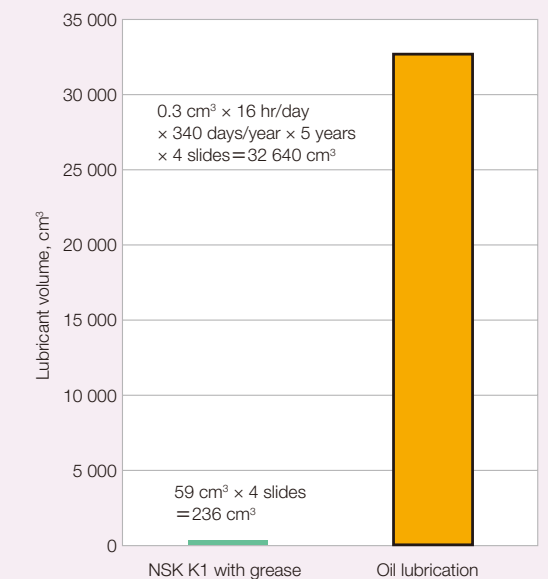

Applications

- Lifter and carrier / • Multi-tier stock systems / • Engine/chassis decking systems / • Underbody line welding machines / • Body line conveyor systems / • Marking machines / • Material handling systems / • Sorting systems / • Assembly vibration testers / • Assembly machines / • Differential gear grinding machines

Introduction of Performance by Use

2 Machine Tools

High-Load Life Test Using Cutting Coolant which is Contaminated with Cast Iron Particles

3 Samples of different lubricant conditions

Test conditions

Sample: LY45BN (Preload Z4)
 Load: 9 800 N per one ball slide
 Preload: 4 400 N Grease: AV2
 Feed: Average 24 m/min Stroke: 400 mm
 Contamination: Coolant dilution 30:1
 FCD45 particles 115 MESH (125 μm or less) added at 5% (by weight)
 Pattern: 2 days in coolant (ball grooves of rail are immersed) 5 days no coolant

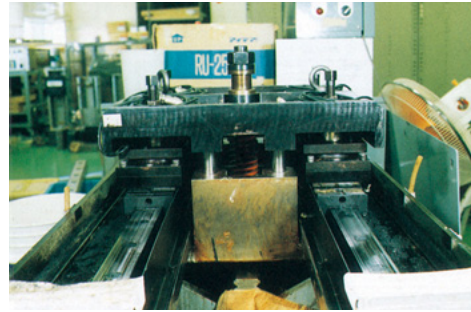

Friction force change

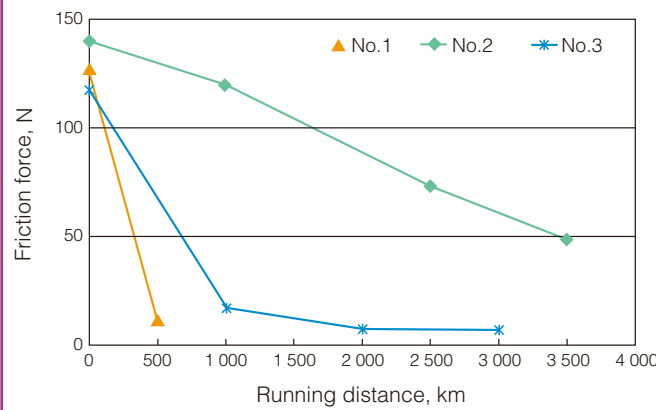

Test results

Sample	Lubricating condition (*1)	Condition			Result Distance (km) Running year (*2)
		Broken end cap	Flaking	Lost Preload	
No.1	Grease only	Yes Test stopped	No	Yes	End cap broke prematurely due to inadequate way of lubrication and particles. 600 km, 0.8 years.
No.2	NSK K1 (4 pcs.) + Grease	No	No	No	Running uninterrupted over 3 600 km, 5 years.
No.3	Oil only	No	Slight	Yes	Shortened life because of particle and inadequate way of lubrication. 3 000 km, 4.1 years.

(*1): No replenishment of grease to sample No.1 and No.2 during test.
 (*2): Running year is calculated by 720 km/year (average 3 m/min × 16 hr/day × 250 days/year).

Merit

- Reduced expense for lubricants (see graph in the right)
- No oil or grease supply systems required
→ **Reduced equipment cost**
- Improved machine design time and efficiency
→ **No piping design required**
- Better for the environment
→ **NSK K1 reduces lubricant consumption, minimizes waste oil**

Comparison of lubricant consumption

Estimated oil consumption in the test equivalent to 5 years running (for 4 LA45 slides)

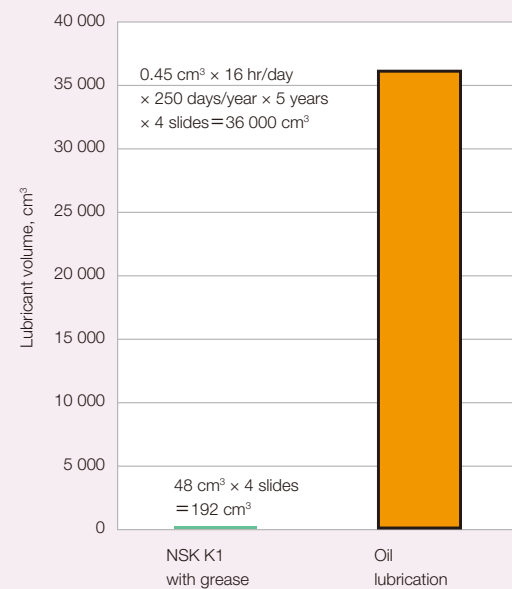

Applications

- Machining centers / • NC Lathes / • Telescopic cover for horizontal machining center / • Laser processing machines (X and Y axes) / • Pallet changer / • Water jet cutter

3 Woodworking Machines

Long Life even with Wood Chip Contamination

Life is 2 times longer than standard double seals in woodworking machines

Comparison test between NSK K1 and standard double seal

Test conditions

Sample: LH30AN (Preload Z1)
 Feed rate: 20 m/min
 Stroke: 400 mm
 Lubrication: Standard double seal - AV2 grease
 NSK K1 - NSK K1 + AV2 grease
 Load: 490 N per one ball slide
 Wood chip contamination: Set the product in the box with bottom area A, then put 240 g of wood chips on the rails. Put back removed wood chips to rails 3 times/day.
 [High volume of chips]: A = 145 mm (width) × 700 mm (length)
 [Medium volume of chips]: A = 170 mm (width) × 700 mm (length)

Running test in wood chips



Test results (high volume of chips)

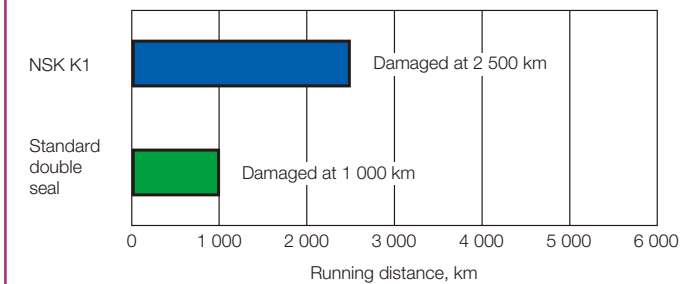

Test results (medium volume of chips)

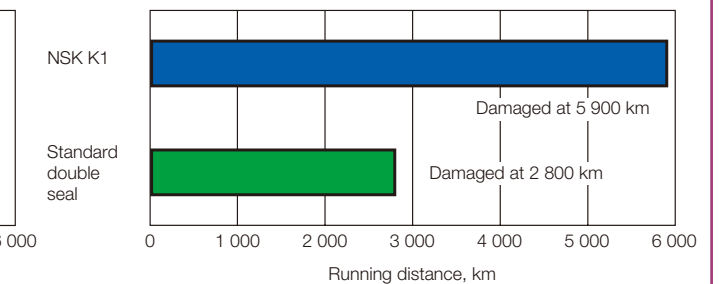

Merit

- No oil or grease supply systems required
→ **Reduced equipment cost**
- Improved machine design time and efficiency
→ **No piping design required**
- Better for the environment
→ **NSK K1 reduces lubricant consumption, minimizes waste oil**

Applications

- Router / • Lumber cutting, groove making machines / • Pre-cutting machines / • Unmanned lumbering machines

Introduction of Performance by Use

4 Semiconductor / LCD Manufacturing Equipment

Low Particle Emission

Combining the NSK K1 with LG2 grease for low particle emission is comparable to using vacuum grease.

Test conditions
Sample: LS20
Speed: 36 m/min

Comparison of particle emission characteristics

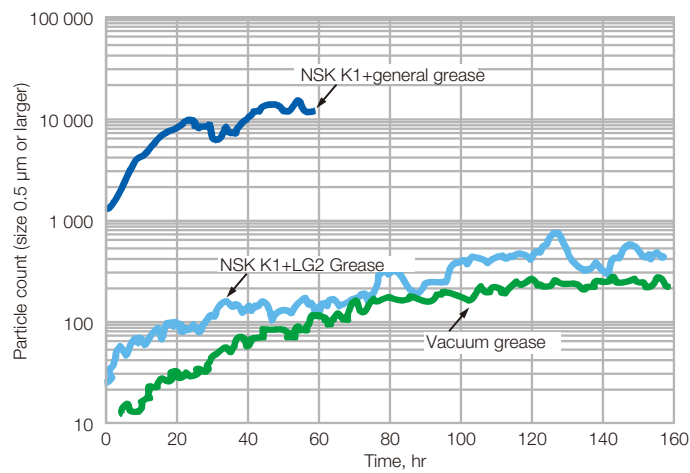

Good Operability (Stable Dynamic Friction Force)

Dynamic friction force is 1/3 of fluorine type grease (at 20 m/min).

Test conditions
Sample: LS20AL
Preload: Z1

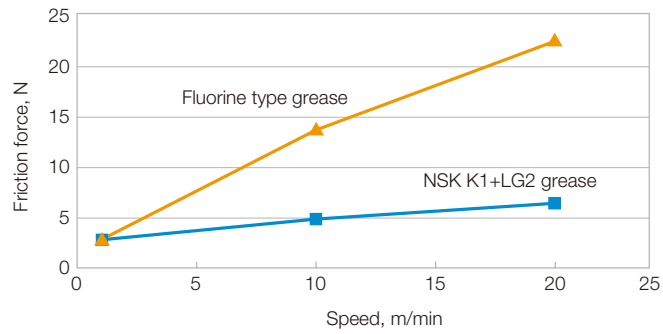

Change of dynamic friction force (100% at the beginning)

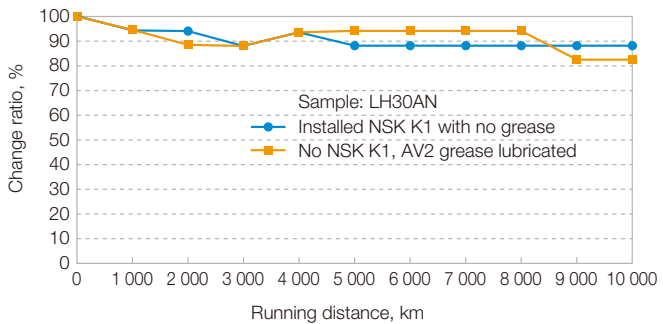

High Performance Lubrication - Maintenance free

Over 30 000 km running with only NSK K1. Improved performance can be expected when used with the LG2 Grease.

Endurance test without additional lubrication

Test conditions
Sample: LH30AN
Preload: Z1, Z3

	High speed test	Medium speed test
Speed:	200 m/min	60 m/min
Stroke:	1 800 mm	750 mm
Load:	63 N/1 ball slide	None

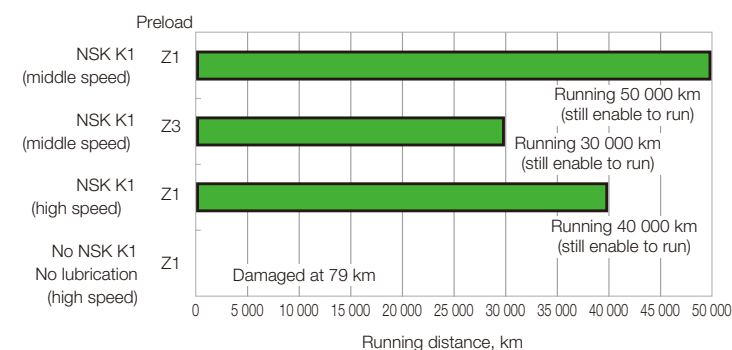

Applications

- LCD substrates polishing machines
- LCD glass substrates transporting machines
- LCD glass substrates testing equipment
- Thin film processing equipment for semiconductors
- Washing machines
- Full automatic wafer mounters
- Washing section of the wafer polishing machines
- Carrier arm section of logic handler
- CMP

5 Food Processing, Medical/Nursing Equipment

Keeps Equipment and Adjacent Areas Clean

Wear life is 3 times longer than normal seals under wet conditions.

Endurance test in water

Test conditions
Sample: LS30 stainless steel
Preload: Z1
Load: 4 700 N per one ball slide
Stroke: 400 mm
Speed: 24 m/min
Lubrication: Grease full pack (Consistency: 280, Viscosity: 580 cst)
Water exposure: Run in water 1 day per week.

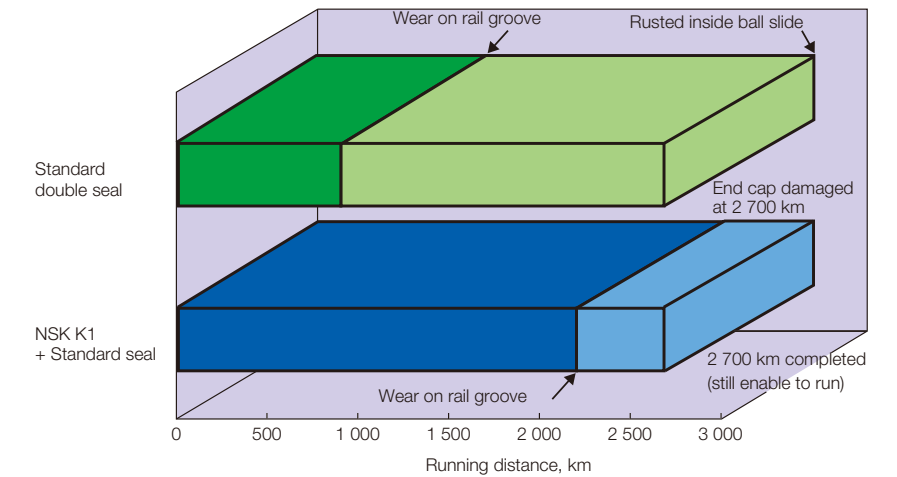

Good Operability (Stable Dynamic friction Force)

Change of oil supply of NSK K1 and dynamic friction force

Test conditions
Sample: LH30AN, preload Z1 (only with NSK K1)
Stroke: 800 mm
Speed: Average 38.4 m/min
Load: None

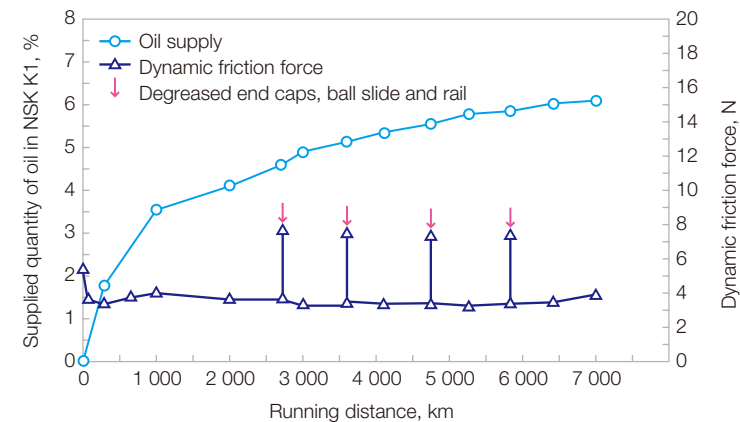

Applications

- Sample preparation systems
- Blood analyzer
- Medical examination tables and bed transfer equipment
- Medical scanner
- Analytic equipment
- Nursing equipment and disabled aids
- Food processing machines
- Food conveyor

Worldwide Sales Offices

NSK LTD.-HEADQUARTERS, TOKYO, JAPAN
 INDUSTRIAL MACHINERY BUSINESS DIVISION-HEADQUARTERS tel: 03-3779-7227
 GLOBAL AFTERMARKET DEPARTMENT tel: 03-3779-7253
 PRECISION MACHINERY DEPARTMENT tel: 03-3779-7163
 MECHATRONICS BUSINESS DEPARTMENT tel: 0466-21-3027
 AUTOMOTIVE BUSINESS DIVISION-HEADQUARTERS tel: 03-3779-7189

Africa
South Africa:
NSK SOUTH AFRICA (PTY) LTD.
 Johannesburg tel: 011-458-3600

Asia and Oceania
Australia:
NSK AUSTRALIA PTY. LTD.
 Melbourne tel: 03-9765-4400

China:
NSK HONG KONG LTD.
 Hong Kong tel: 02739-9933
 Shenzhen tel: 0755-25904886

KUNSHAN NSK CO., LTD.
 Kunshan tel: 0512-5771-5654

CHANGSHU NSK NEEDLE BEARING CO., LTD.
 Jiangsu tel: 0512-5230-1111

NSK STEERING SYSTEMS DONGGUAN CO., LTD.
 Dongguan tel: 0769-2262-0960

NSK (CHINA) RESEARCH & DEVELOPMENT CO., LTD.
 Jiangsu tel: 0512-5796-3000

NSK (SHANGHAI) TRADING CO., LTD.
 Jiangsu tel: 0512-5796-3000

NSK (CHINA) INVESTMENT CO., LTD.
 Jiangsu tel: 0512-5796-3000

Beijing tel: 010-6590-8161
 Tian Jin tel: 022-8319-5030
 Changchun tel: 0431-8898-8682
 Shenyang tel: 024-2334-2868
 Dalian tel: 0411-8800-8168
 Nanjing tel: 025-8472-6671
 Fuzhou tel: 0591-8380-1030
 Wuhan tel: 027-8556-9630
 Qingdao tel: 0532-5568-3877
 Guangzhou tel: 020-3817-7800
 Changsha tel: 0731-8571-3100
 Luoyang tel: 0379-6069-6188
 Xi'an tel: 029-8765-1896
 Chongqing tel: 023-6806-5310
 Chengdu tel: 028-8528-3680

NSK CHINA SALES CO., LTD.
 Jiangsu tel: 0512-5796-3000

India:
RANE NSK STEERING SYSTEMS LTD.
 Chennai tel: 044-474-06017

NSK INDIA SALES CO. PVT. LTD.
 Chennai tel: 044-2847-9600
 Gurgaon tel: 0124-4104-530
 Kolkata tel: 033-4001-2062
 Mumbai tel: 022-2838-7787

NSK-ABC BEARINGS LTD.
 Chennai tel: 044-2714-3000

Indonesia:
PT. NSK INDONESIA
 Jakarta tel: 021-252-3458

Korea:
NSK KOREA CO., LTD.
 Seoul tel: 02-3287-0300
 Changwon tel: 055-287-6001

Malaysia:
NSK BEARINGS (MALAYSIA) SDN.BHD.
 Shah Alam tel: 03-7803-8859

New Zealand:
NSK NEW ZEALAND LTD.
 Auckland tel: 09-276-4992

Philippines:
NSK REPRESENTATIVE OFFICE
 Manila tel: 02-893-9543

Singapore:
NSK INTERNATIONAL (SINGAPORE) PTE LTD.
 Singapore tel: 6496-8000

NSK SINGAPORE (PRIVATE) LTD.
 Singapore tel: 6496-8000

Taiwan:
TAIWAN NSK PRECISION CO., LTD.
 Taipei tel: 02-2509-3305

TAIWAN NSK TECHNOLOGY CO., LTD.
 Taipei tel: 02-2509-3305

Thailand:
NSK BEARINGS (THAILAND) CO., LTD.
 Bangkok tel: 02320-2555

SIAM NSK STEERING SYSTEMS CO., LTD.
 Chachoengsao tel: 038-522-343

NSK ASIA PACIFIC TECHNOLOGY CENTER (THAILAND) CO., LTD.
 Chonburi tel: 038-454-631

Vietnam:
NSK VIETNAM CO., LTD.
 Hanoi tel: 04-3955-0159

NSK REPRESENTATIVE OFFICE
 Ho Chi Minh City tel: 08-3822-7907

Europe
NSK EUROPE LTD. (EUROPEAN HEADQUARTERS)
 Maidenhead tel: 01628-509-800

France:
NSK FRANCE S.A.S.
 Paris tel: 01-30-57-39-39

Germany:
NSK DEUTSCHLAND GMBH
 Düsseldorf tel: 02102-4810

Italy:
NSK ITALIA S.P.A.
 Milano tel: 0299-5191

Poland:
NSK EUROPE LTD. WARSAW LIAISON OFFICE
 Warsaw tel: 022-645-1525

NSK STEERING SYSTEMS EUROPE (POLSKA) SP.Z O.O.
 Walbrzych tel: 074-664-4101

NSK NEEDLE BEARING POLAND SP.Z O.O.
 Kielce tel: 041-345-2469

NSK POLSKA SP.Z O.O.
 Kielce tel: 041-347-5110

Spain:
NSK SPAIN S.A.
 Barcelona tel: 093-433-5775

Turkey:
NSK RULMANLARI ORTA DOGU TIC. LTD. STI.
 Istanbul tel: 0216-355-0398

United Kingdom:
NSK EUROPEAN TECHNOLOGY CENTRE
 Newark tel: 01636-605-123

NSK UK Ltd.
 Newark tel: 01636-605-123

North and South America
NSK AMERICAS, INC. (AMERICAN HEADQUARTERS)
 Ann Arbor tel: 734-913-7500

Argentina:
NSK ARGENTINA SRL
 Buenos Aires tel: 11-4704-5100

Brazil:
NSK BRASIL LTDA.
 São Paulo tel: 011-3269-4786

Canada:
NSK CANADA INC.
 Toronto tel: 905-890-0740

Mexico:
NSK RODAMIENTOS MEXICANA, S.A. DE C.V.
 Mexico City tel: 55-3682-2900

United States of America:
NSK CORPORATION
 Ann Arbor tel: 734-913-7500

NSK AMERICAN TECHNOLOGY CENTER
 Ann Arbor tel: 734-913-7500

NSK PRECISION AMERICA, INC.
 Franklin tel: 317-738-5000

NSK STEERING SYSTEMS AMERICA, INC.
 Bennington tel: 802-442-5448

NSK LATIN AMERICA, INC.
 Miami tel: 305-477-0605

<As of June 2012>

For the latest information, please refer to the NSK website.

www.nsk.com

NSK Ltd. has a basic policy not to export any products or technology designated as controlled items by export-related laws. When exporting the products in this brochure, the laws of the exporting country must be observed. Specifications are subject to change without notice and without any obligation on the part of the manufacturer. Every care has been taken to ensure the accuracy of the data contained in this brochure, but no liability can be accepted for any loss or damage suffered through errors or omissions. We will gratefully acknowledge any additions or corrections.

For more information about NSK products, please contact: _____

